

# L5 Linear All In Style



## LP-L5-P160-144 BPS DALI 850

Art. No 555531370



Luminous flux	4960 lm
Luminaire efficiency	124 lm/W
CRI	> 80
Correlated colour temperature	5000 K
Rated power	40 W
LED	Samsung LM561B
Dimmable	YES - to 1%
Input current	0.173 A
Working voltage	AC 220-240 V
Ingress protection code	IP54
Mech. impact protection code	-
Working temperature	-30 to +40°C

Service life	100 000 hours at 80% luminous flux
Housing	Aluminium
Diffuser	PMMA
Installation	Surface mounting or suspended on wire/chain
Dimensions – LxWxH	1580x124x93 mm
Weight	-
Mark	CE, RoHS
Origin	EU
Manufacturer	Solar LED Power Ltd.



Dimensional drawing:

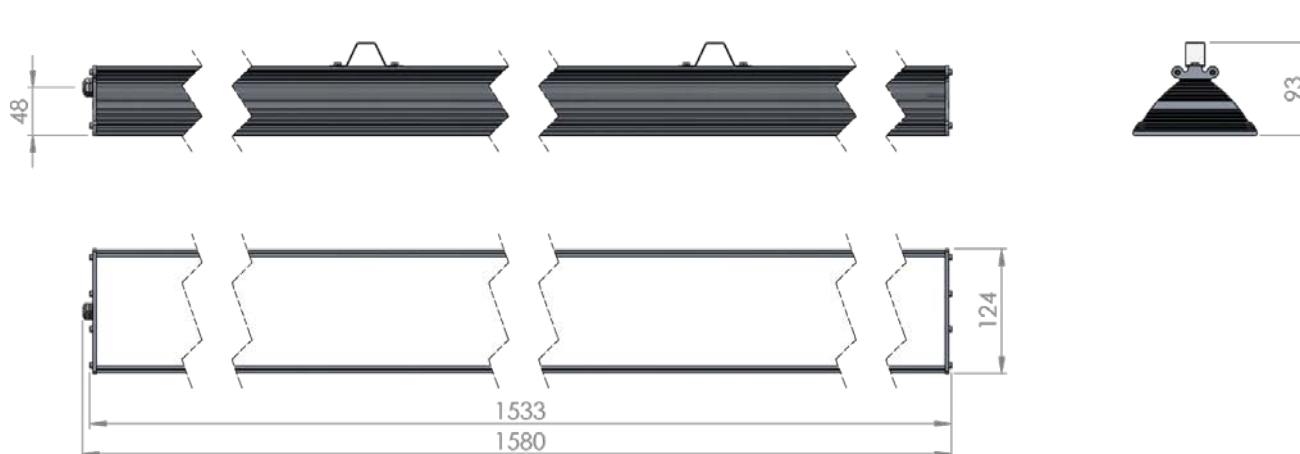

Solar LED Power Ltd. is constantly developing and improving its products. The right is reserved to change specifications without prior notification.