

L3 Linear Style

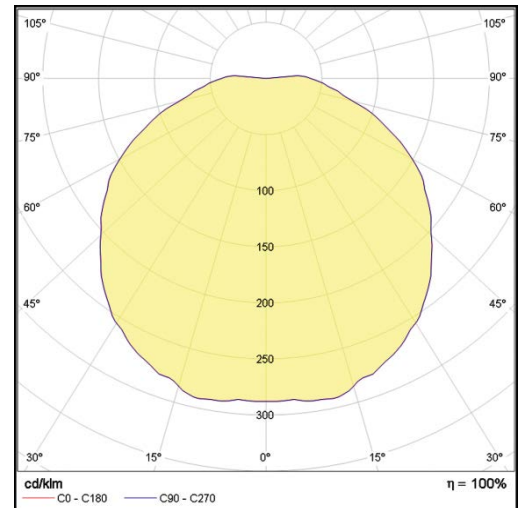

LP-L3-30X30FR-96 840

Art. No 530411093



Luminous flux	3520 lm
Luminaire efficiency	126 lm/W
CRI	> 80
Correlated colour temperature	4000 K
Rated power	28 W
LED	Samsung LM561B
Dimmable	NO
Input current	0.122 A
Working voltage	AC 220-240 V
Ingress protection code	IP20
Mech. impact protection code	-
Working temperature	-20 to +40°C

Service life	80 000 hours at 80% luminous flux
Housing	Aluminium
Diffuser	Polystyrol
Installation	Surface mounting or suspended on wire
Dimensions – LxWxH	351x351x25 mm
Weight	-
Mark	CE, RoHS
Origin	EU
Manufacturer	Solar LED Power Ltd.



Dimensional drawing:

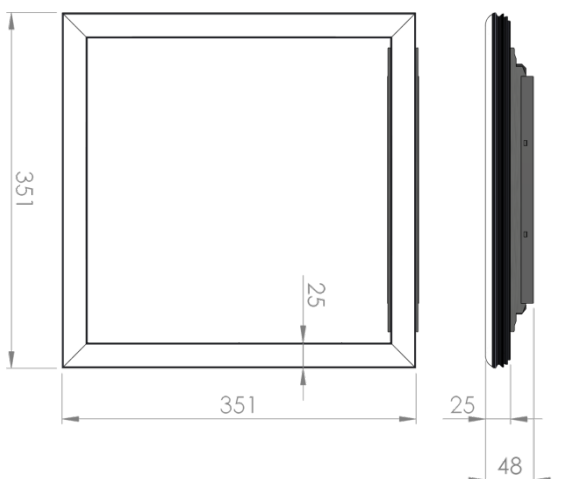

Solar LED Power Ltd. is constantly developing and improving its products. The right is reserved to change specifications without prior notification.