

L2 Architectural Style

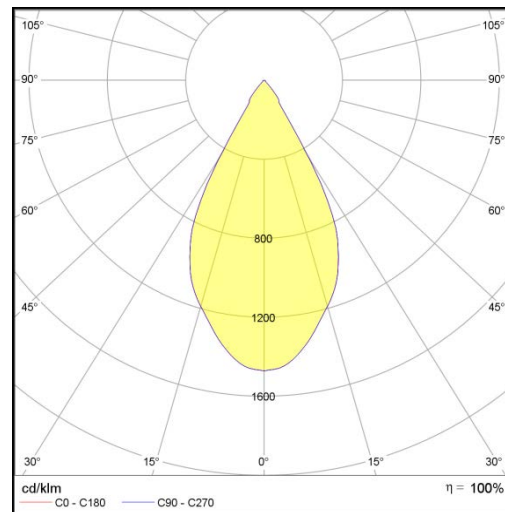

LP-L2-4014 60° 850

Art. No 130511574



Luminous flux	1400 lm
Luminaire efficiency	70 lm/W
CRI	> 80
Correlated colour temperature	5000 K
Rated power	20 W
LED	PROLight
Dimmable	NO
Input current	0.087 A
Working voltage	AC 220-240 V
Ingress protection code	IP67
Mech. impact protection code	IK08
Working temperature	-50 to +45°C

Service life	80 000 hours at 80% luminous flux
Housing	Aluminium
Diffuser	Tempered Glass
Installation	Surface mounting
Dimensions – LxWxH	391x140x91 mm
Weight	-
Mark	CE, RoHS
Origin	EU
Manufacturer	Solar LED Power Ltd.



Dimensional drawing:

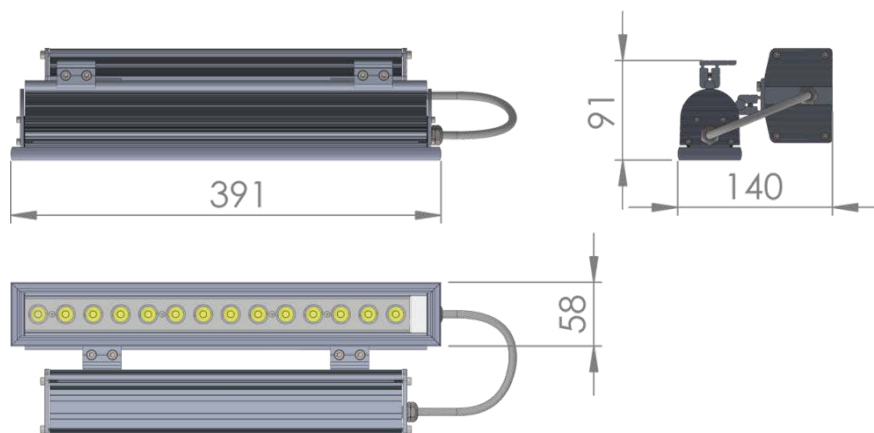

Solar LED Power Ltd. is constantly developing and improving its products. The right is reserved to change specifications without prior notification.